

770 Nylon Protection Cable Chain with opening covers

Inner height (D) 51 mm

Double share Sideband & Frame construction with large anti-friction single-pin. Covers are opening from inner radius.

Vertical separators are available.

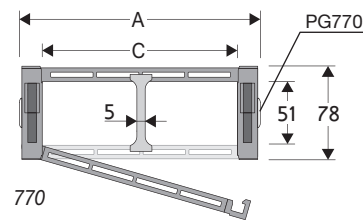

770

Separator

- Unassembled Part.no S770
- Assembled Part.no S770MC

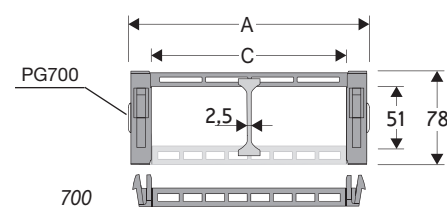

700

Separator

- Unassembled Part.no S700
- Assembled Part.no S700MC

Technical characteristics when self-supported

Speed	6 m/s
Acceleration	30 m/s ²

For higher requirements please consult our technical dept.

A	B	C	D	R	Weight/m	Chain
mm	mm	mm	mm	mm	kg	Part Number
120	78	85	51	150-200-250-300	3,30	770085 □□□ *
135	78	100	51	150-200-250-300	3,90	770100 □□□ *
185	78	150	51	150-200-250-300	4,10	770150 □□□ *
235	78	200	51	150-200-250-300	4,50	770200 □□□ *
285	78	250	51	150-200-250-300	5,00	70025 □□ **

*Complete the code by inserting the value of the radius (R): Ex. 770085 □□□□

**Complete the code by inserting the value of the radius (R): Ex. 70025 □□

Where: 0=150; 1=200; 2=250; 3=300

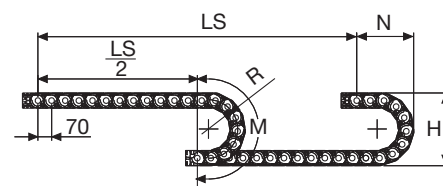

R	H	N	M
mm	mm	mm	mm
150	378	260	615
200	478	310	770
250	578	365	930
300	678	410	1085

Length of chain (L)

Half travel distance ($\frac{LS}{2}$) plus length of curve (M)

$$L = \frac{LS}{2} + M$$



Self-Supporting Capacity Diagram

The maximum length of the self-supporting capacity ($\frac{LS}{2}$) in relationship to the weight of the cables and hoses contained per linear metre.

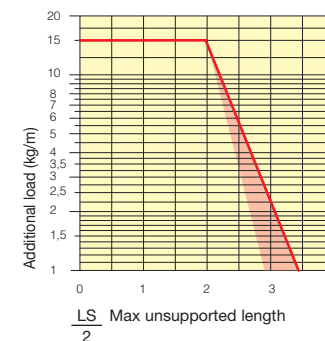

End Brackets

The end brackets set allows the two ends of the chain to be attached to the equipment.

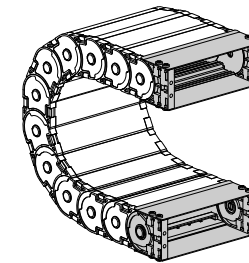
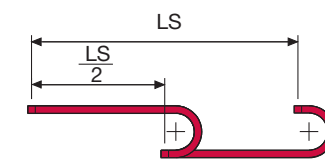
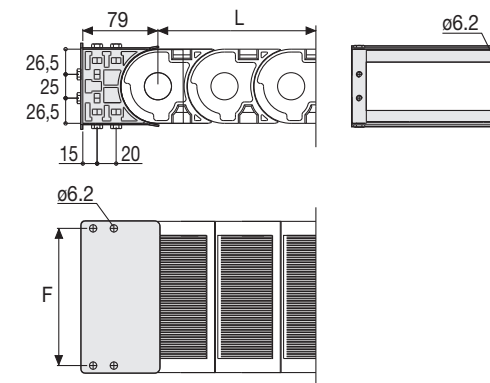

Fig. A
The chain can be fixed frontally, inner or outer radius. (Fig A)



The red marking in the diagram area considers the difference of weight between various widths of chain.



Chain Type	F mm
770 C=85	100
770 C=100	115
770 C=150	165
770 C=200	215
700 C=250	265

Nylon Type Part Numbers

Chain Type	End Brackets Set
770...	AN770□□□*KM
700 C=250	AL700KM

Chain Type	End Brackets Set
770...	AN770□□□*K
700 C=250	AL700K

* Inner width (C)

770 Nylon Protection Cable Chain with opening covers

How to open the cover.

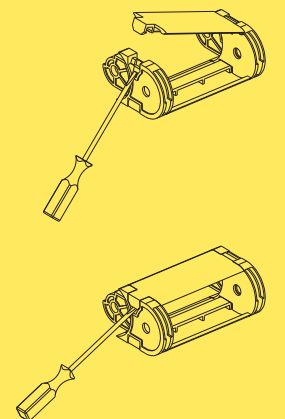

Special tool to remove the connecting pivots:
Part Number PZ010.



For further information please consult Brevetti Stendalto's Technical Office